



Please write clearly in block capitals.

Centre number

--	--	--	--	--

Candidate number

--	--	--	--

Surname

---

Forename(s)

---

Candidate signature

---

I declare this is my own work.

# A-level PHYSICS

## Paper 2

Friday 9 June 2023

Morning

Time allowed: 2 hours

### Materials

For this paper you must have:

- a pencil and a ruler
- a scientific calculator
- a Data and Formulae Booklet
- a protractor.

### Instructions

- Use black ink or black ball-point pen.
- Fill in the boxes at the top of this page.
- Answer **all** questions.
- You must answer the questions in the spaces provided. Do not write outside the box around each page or on blank pages.
- If you need extra space for your answer(s), use the lined pages at the end of this book. Write the question number against your answer(s).
- Do all rough work in this book. Cross through any work you do not want to be marked.
- Show all your working.

### Information

- The marks for questions are shown in brackets.
- The maximum mark for this paper is 85.
- You are expected to use a scientific calculator where appropriate.
- A Data and Formulae Booklet is provided as a loose insert.

For Examiner's Use	
Question	Mark
1	
2	
3	
4	
5	
6	
7	
8–32	
<b>TOTAL</b>	



J U N 2 3 7 4 0 8 2 0 1

1B/M/Jun23/E7

**7408/2**

## Section A

Do not write  
outside the  
boxAnswer **all** questions in this section.

0 1 . 1

State what is meant by the internal energy of an ideal gas.

[1 mark]

---



---



---

**Figure 1** shows a single gas particle **P** of an ideal gas inside a hollow cube.

Figure 1

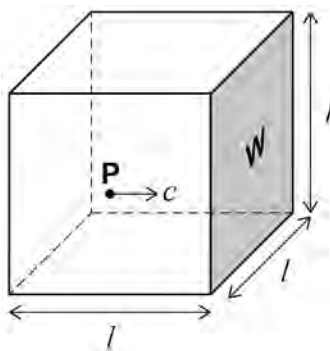
The cube has side length  $l$  and volume  $V$ .**P** has mass  $m$  and is travelling at a velocity  $c$  perpendicular to side **W**.

0 1 . 2

Explain why **P** has a change in momentum of  $-2mc$  during one collision with **W**.

[1 mark]

---



---



---



**0 1 . 3** **P** collides repeatedly with **W**.

Show that the frequency  $f$  of collisions is  $\frac{c}{2l}$ .

**[1 mark]**

**0 1 . 4** Deduce an expression, in terms of  $m$ ,  $c$  and  $V$ , for the contribution of **P** to the pressure exerted on **W**.  
Refer to appropriate Newton's laws of motion.

**[2 marks]**

---

---

---

---

**5**

**Turn over for the next question**

**Turn over ►**



0 2

**Figure 2** shows a wheel used in motorsport. A rubber tyre is fitted around a cylindrical metal rim. The tyre is filled with a gas. The dimensions shown in **Figure 2** are for the volume of the gas in the tyre.

Assume that this volume remains constant throughout this question.

**Figure 2**

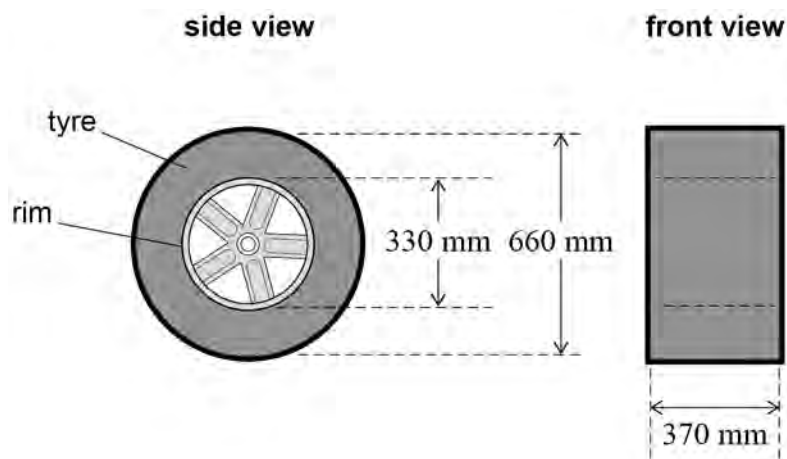

0 2 . 1

The mass of the wheel is measured when the gas in the tyre is at a pressure of  $1.01 \times 10^5$  Pa.

More of the same gas is added to the tyre and the mass of the wheel is measured again.

**Table 1** shows the pressure in the tyre and the mass of the wheel before and after the addition of the extra gas.

The gas is kept at a constant temperature of  $100^\circ\text{C}$ .

**Table 1**

	Pressure in tyre / Pa	Mass of wheel / kg
Before	$1.01 \times 10^5$	14.897
After	$2.11 \times 10^5$	14.991

Do not write  
outside the  
box



Determine, in  $\text{kg mol}^{-1}$ , the molar mass of the gas.

[5 marks]

Do not write  
outside the  
box

molar mass = \_\_\_\_\_  $\text{kg mol}^{-1}$

0 2 . 2

Motorsport regulations specify a minimum amount of gas in the tyre.

The amount of gas in the tyre is checked by measuring the pressure before the wheel is put onto the car. The regulations also specify a maximum temperature for the tyre when making this measurement.

Explain why a maximum temperature is specified.

[2 marks]

---

---

---

---

---

---

---

7

Turn over ►



**0 3 . 1** Describe **two** properties of a radial gravitational field.

**[2 marks]**

1 \_\_\_\_\_

2 \_\_\_\_\_

A space probe is launched from the Earth's surface.

**Figure 3** shows how the gravitational force acting on the space probe varies with height above the Earth's surface.

**Figure 3**

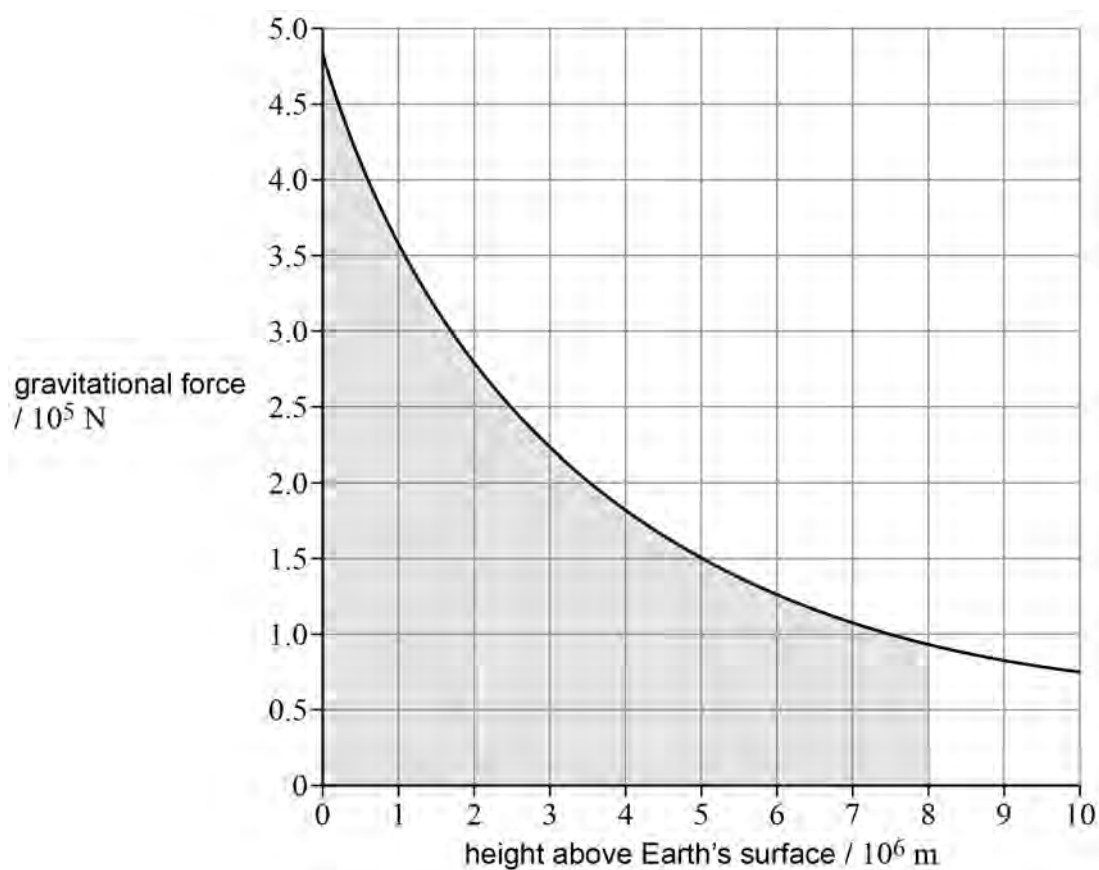

**0 3 . 2** State the physical significance of the shaded area in **Figure 3**.

**[1 mark]**

\_\_\_\_\_

\_\_\_\_\_



At the Earth's surface,

- the gravitational field strength of the Sun is  $g_S$
- the gravitational field strength of the Earth is  $g_E$ .

**0 3 . 3** Calculate  $\frac{g_S}{g_E}$ .

distance from the Earth to the Sun =  $1.50 \times 10^{11}$  m

**[2 marks]**

$$\frac{g_S}{g_E} = \underline{\hspace{10em}}$$

**0 3 . 4** Explain why  $g_S$  is more important than  $g_E$  in predicting the motion of the space probe as it escapes from the Solar System.

**[1 mark]**

---

---

---

**Question 3 continues on the next page**

**Turn over ►**



03.5

The space probe eventually reaches a point where the gravitational influence of the Solar System is negligible.

The probe is unpowered as it approaches an isolated interstellar body **X**.

The gravitational field of **X** changes the kinetic energy of the space probe.

**Table 2** shows the distance of the space probe from the centre of mass of **X** and the speed for two positions **A** and **B** of the space probe.

**Table 2**

	Distance of space probe from centre of mass of <b>X</b> / $10^6$ m	Speed of space probe / $10^3$ m s <sup>-1</sup>
<b>A</b>	6.0	1.1
<b>B</b>	0.17	1.3

The space probe has a mass of  $4.9 \times 10^4$  kg.

Calculate the mass of **X**.

**[4 marks]**

mass of **X** = \_\_\_\_\_ kg

10





**Turn over for the next question**

*Do not write  
outside the  
box*

**DO NOT WRITE ON THIS PAGE  
ANSWER IN THE SPACES PROVIDED**

**Turn over ►**



0 4

Figure 4 shows a spark detector used to detect alpha particles.

Do not write outside the box

Figure 4

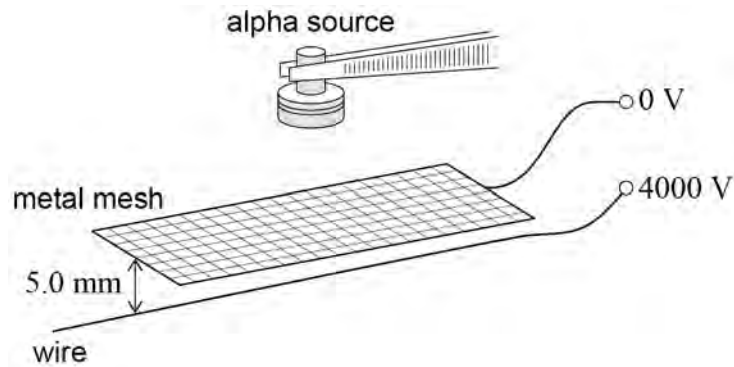

The detector consists of a metal mesh placed 5.0 mm above a wire. A potential difference of 4000 V is applied between the mesh and the wire.

Molecules in the air between the mesh and the wire are ionised by an alpha particle and a spark is produced.

Figure 5 shows equipotentials between the mesh and the wire.

Figure 5

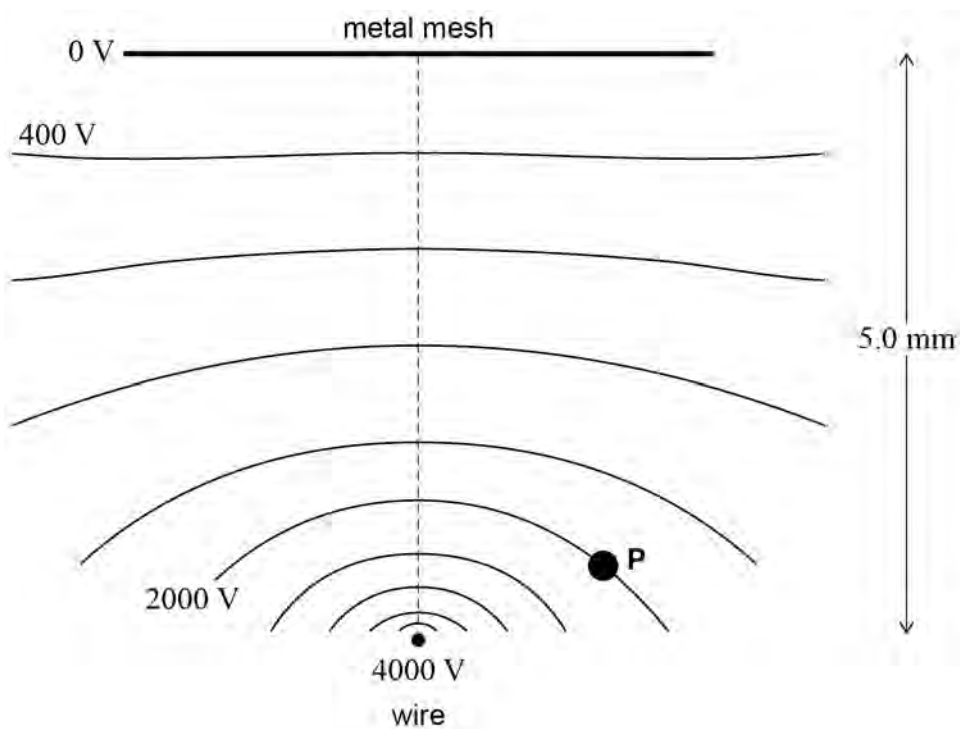

**0 4 . 1** **Figure 5** shows a dashed line between the mesh and the wire.

Sketch on **Figure 6** a graph to show how the magnitude  $E$  of the electric field strength varies with the distance  $d$  from the mesh along this dashed line.

No values are required on the  $E$  axis.

**[2 marks]**

**Figure 6**

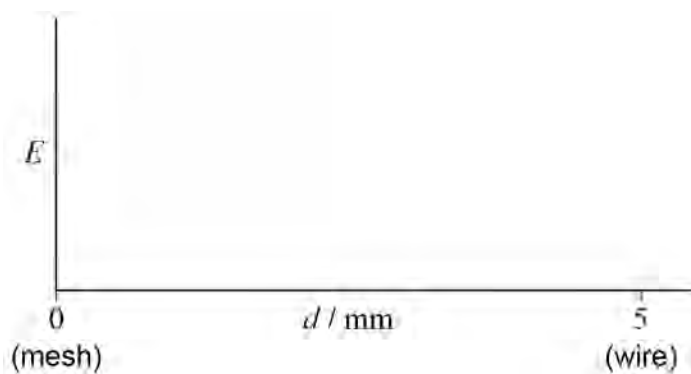

An alpha particle passes through the mesh.

The alpha particle ionises an argon atom at **P** on **Figure 5**, releasing one electron.

The electron and the argon ion have no kinetic energy at **P**.

The electron then travels to the wire and the argon ion travels to the mesh.

**0 4 . 2** Calculate the ratio  $\frac{\text{speed of electron when it reaches the wire}}{\text{speed of argon ion when it reaches the mesh}}$ .

Assume that the air has no effect on the motion of the electron or on the motion of the argon ion.

$$\text{mass of argon ion} = 6.64 \times 10^{-26} \text{ kg}$$

**[2 marks]**

ratio = \_\_\_\_\_

**Question 4 continues on the next page**

**Turn over ►**



0 4 . 3

In practice, the air **does** affect the motion of the electron and the motion of the argon ion.

Suggest how the presence of air between the mesh and the wire changes the ratio in Question **04.2**.

No numerical detail is required.

[1 mark]

---



---



---

0 4 . 4

The alpha source in **Figure 4** is moved to different heights  $h$  above the mesh.

**Figure 7** shows how the number of sparks  $N$  produced in 10 minutes varies with  $h$ . No sparks are produced when the source is not present.

**Figure 7**

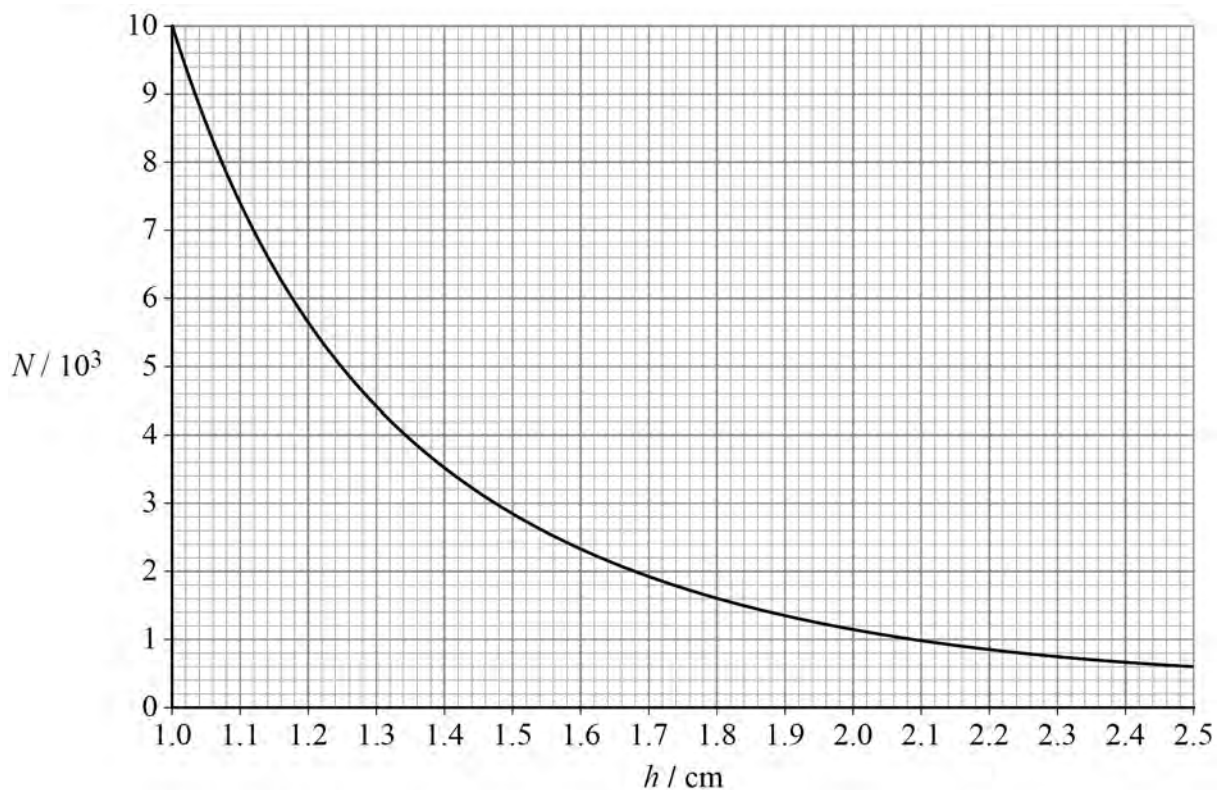

Student **A** suggests that the spark rate obeys an inverse-square law.  
Student **B** suggests that the spark rate decreases exponentially with  $h$ .

Determine whether either student is correct.

**[3 marks]**

*Do not write  
outside the  
box*

8

**Turn over for the next question**

**Turn over ►**



**There are no questions printed on this page**

*Do not write  
outside the  
box*

**DO NOT WRITE ON THIS PAGE  
ANSWER IN THE SPACES PROVIDED**



0 5

**Figure 8** shows a circuit used to investigate the charge and discharge of a capacitor of capacitance  $C$  using resistors of resistances  $R_1$  and  $R_2$ .

Do not write  
outside the  
box

**Figure 8**

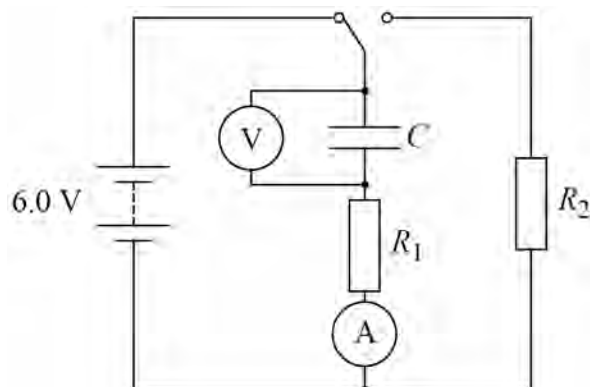

The battery has an emf of 6.0 V and negligible internal resistance.

0 5 . 1

Show that the time taken for the capacitor to charge from 2.0 V to 4.0 V is approximately  $0.7R_1C$ .

**[3 marks]**

Question 5 continues on the next page

Turn over ►



The capacitor is fully discharged.

The capacitor is then charged until the potential difference (pd) across it is 4.0 V.

**Figure 9** shows the variation with time of the ammeter reading as the capacitor is charged.

Do not write  
outside the  
box

**Figure 9**

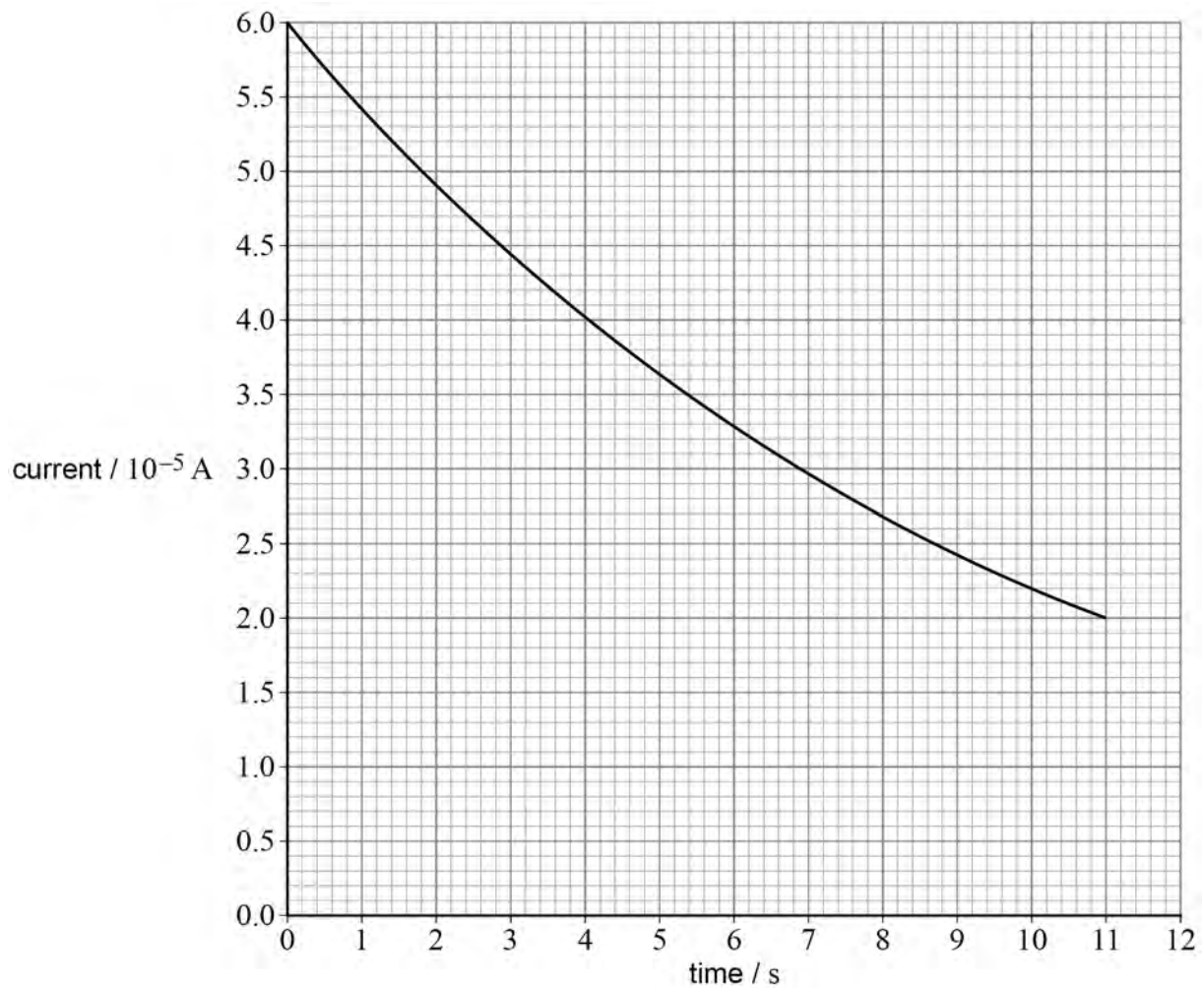



05.2

Show that the capacitance of the capacitor is about  $1 \times 10^{-4}$  F.

**[4 marks]**

*Do not write  
outside the  
box*

**Question 5 continues on the next page**

**Turn over ►**

0 5 . 3

When the pd reaches 4.0 V the switch is immediately set to discharge the capacitor. When the pd reaches 2.0 V the switch is immediately set to charge the capacitor.

Do not write outside the box

Figure 10 shows how the pd across the capacitor varies with time.

Figure 10

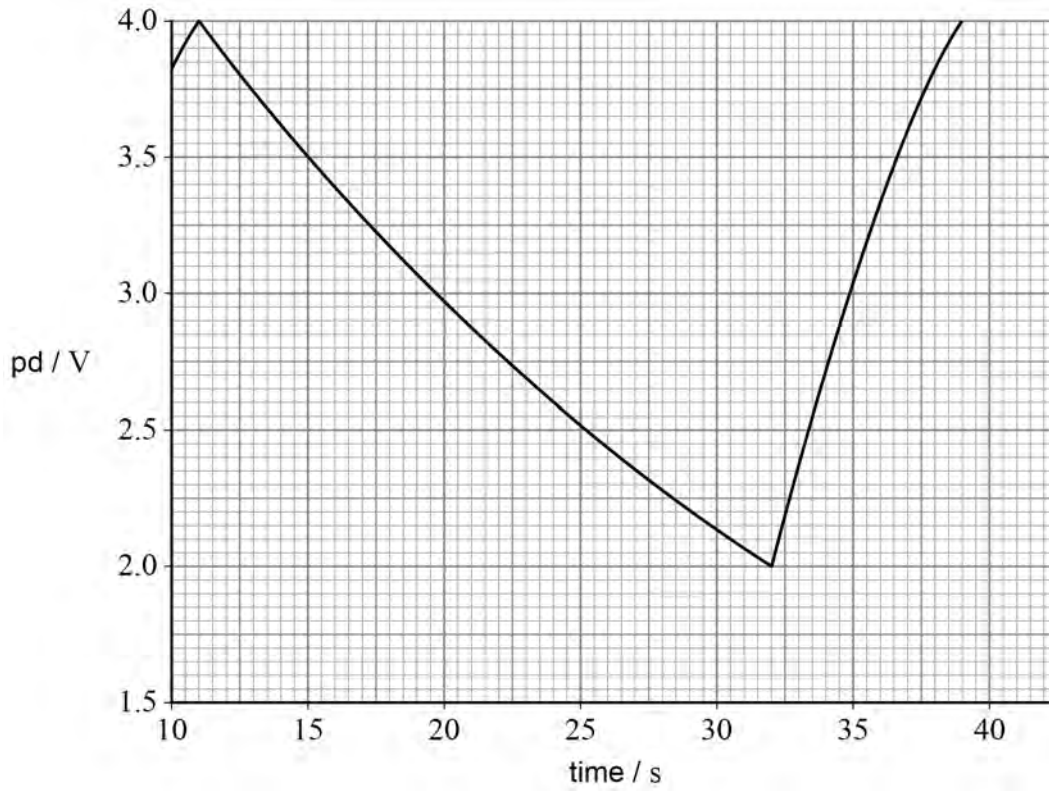

Determine the value of  $R_2$ .

[3 marks]

$R_2 =$  \_\_\_\_\_  $\Omega$

10



0	6	.	1
---	---	---	---

Nuclear radii can be estimated using either alpha particles or high-energy electrons.

State **two** advantages of using high-energy electrons rather than alpha particles for this estimate.

**[2 marks]**

1 \_\_\_\_\_

\_\_\_\_\_

\_\_\_\_\_

2 \_\_\_\_\_

\_\_\_\_\_

\_\_\_\_\_

**Question 6 continues on the next page**

**Turn over ►**



0 6 . 2

**Figure 11** shows a beam of electrons, each with the same high energy, incident on a target gas. The electrons are diffracted by the nuclei in the gas. The intensities of these diffracted electrons are measured at various angles  $\theta$ . The data are used to determine the nuclear radius  $R$  of the atoms in the gas.

**Figure 11**

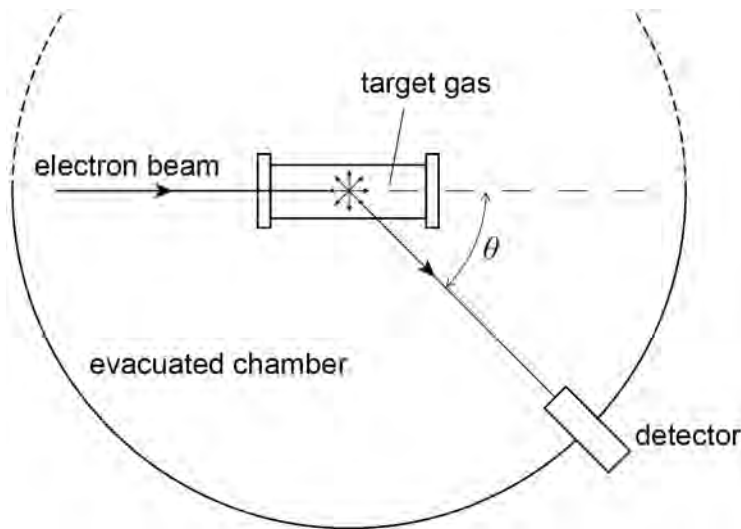

Sketch on **Figure 12** a graph showing how the electron intensity varies with  $\theta$ .

[2 marks]

**Figure 12**

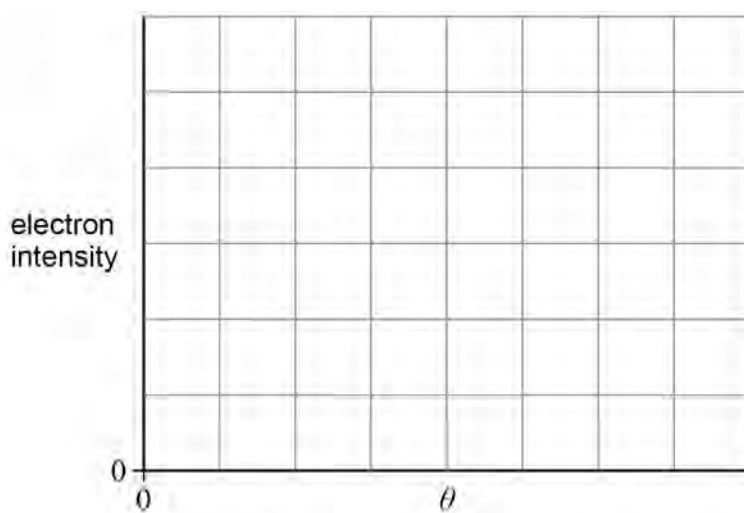

0 6 . 3

The radius  $R$  of a nucleus is related to its nucleon number by  $R = R_0 A^{\frac{1}{3}}$ .

Show that this equation is consistent with the idea that all nuclei have the same density.

[2 marks]

0 6 . 4

The equation  $R = R_0 A^{\frac{1}{3}}$  is derived from experimental data.

Suggest **one** reason why the constant density of nuclear material derived from this equation is only approximate.

[1 mark]

---



---



---

0 6 . 5

The measured radius  $R$  of  ${}_{17}^{35}\text{Cl}$  is  $4.02 \times 10^{-15}$  m.

Calculate an estimate of

- the constant  $R_0$
- the density of nuclear material.

[3 marks]

$R_0 =$  \_\_\_\_\_ m      density = \_\_\_\_\_  $\text{kg m}^{-3}$

10

Turn over ►



**0 7 . 1** Carbon is used as the moderator in some thermal nuclear reactors.

Identify **one** other material commonly used as a moderator.

[1 mark]

---

**0 7 . 2** State **two** benefits of slowing down the neutrons released during fission.

[2 marks]

1 \_\_\_\_\_

---

2 \_\_\_\_\_

---

**0 7 . 3** The collision of a neutron with the nucleus of a moderator atom is modelled using two gliders on a horizontal frictionless air track.

In **Figures 13** and **14** the glider **N** of mass  $m_N$  represents the neutron and the glider **M** of mass  $m_M$  represents the moderator nucleus.

**Figure 13** shows glider **N** travelling with initial speed  $u$  towards the stationary glider **M**.

**Figure 13**

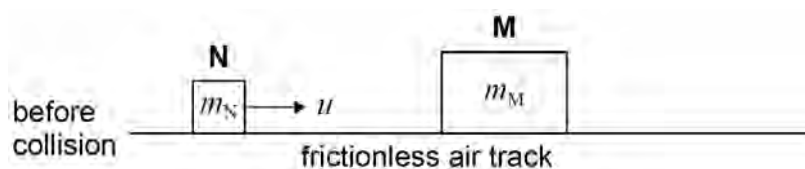

The gliders collide. **N** rebounds with speed  $v$  as shown in **Figure 14**.

**Figure 14**

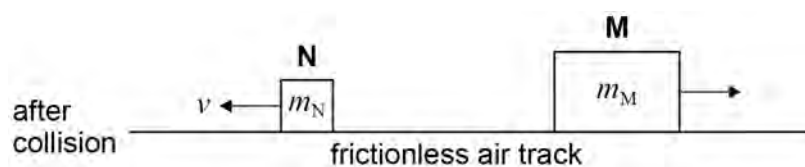
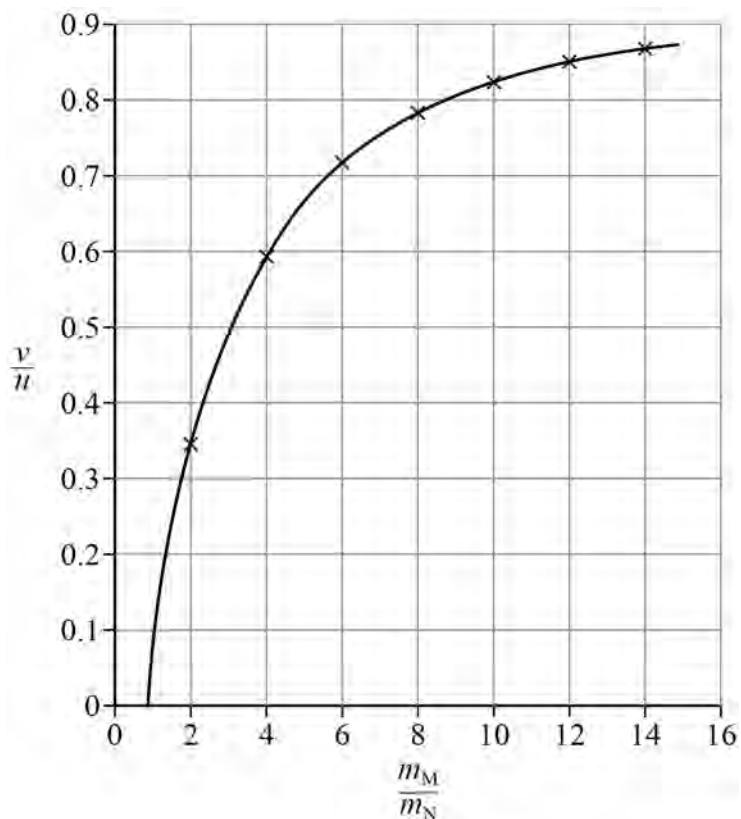

Figure 15 shows the variation of the ratio  $\frac{v}{u}$  with the ratio  $\frac{m_M}{m_N}$ .

Do not write  
outside the  
box

Figure 15



Show that when  $\frac{m_M}{m_N}$  is 12, **N** loses about 30% of its initial kinetic energy in the collision.

[2 marks]

Question 7 continues on the next page

Turn over ►



07.4

In a reactor, the speed of a fast-moving neutron is reduced by a series of  $y$  random collisions with carbon-12 nuclei.

The final kinetic energy  $E_f$  of the neutron is

$$E_f = E_0 e^{-by}$$

where  $E_0$  is the initial kinetic energy of the neutron and  $b = 0.73$

A thermal neutron has kinetic energy equivalent to that of the average particle of an ideal gas with a temperature of 350 K.

One neutron has an initial kinetic energy of 1.0 MeV.

Calculate the minimum value of  $y$  required so that this neutron becomes a thermal neutron.

**[3 marks]**

$y =$  \_\_\_\_\_





07.5

Explain, with reference to **Figure 15**, why elements with a small nucleon number are preferred as moderator materials.

[2 marks]

---

---

---

---

---

---

---

Do not write  
outside the  
box

10

END OF SECTION A

Turn over ►



## Section B

Each of Questions **08** to **32** is followed by four responses, **A**, **B**, **C** and **D**.

For each question select the best response.

Do not write  
outside the  
box

Only **one** answer per question is allowed.

For each question, completely fill in the circle alongside the appropriate answer.

CORRECT METHOD

WRONG METHODS

If you want to change your answer you must cross out your original answer as shown. 

If you wish to return to an answer previously crossed out, ring the answer you now wish to select as shown. 

You may do your working in the blank space around each question but this will not be marked.  
Do **not** use additional sheets for this working.

- 0 8** A 1000 W heater is 75% efficient. The heater is used to increase the temperature of some water from 10 °C to 85 °C in 7 hours.

What mass of water is heated?

specific heat capacity of water = 4200 J kg<sup>-1</sup> K<sup>-1</sup>

[1 mark]

- A** 1.0 kg
- B** 13 kg
- C** 60 kg
- D** 110 kg

- 0 9** Which can lead to a value for the absolute zero of temperature?

[1 mark]

- A** Boyle's law
- B** Brownian motion
- C** Charles's law
- D** Rutherford scattering



**1 0**

Two protons are separated by a distance of  $1 \times 10^{-9}$  m.

Which is an estimate of  $\frac{\text{electric repulsion force}}{\text{gravitational attraction force}}$  for these two protons?

**[1 mark]**

**A**  $10^{18}$

**B**  $10^{28}$

**C**  $10^{36}$

**D**  $10^{45}$

**1 1**

Data are collected for the mass  $M$ , radius  $R$  and escape velocity  $u$  for each planet in the Solar System.

The data show that  $u$  is directly proportional to

**[1 mark]**

**A**  $\left(\frac{M}{R}\right)^{\frac{1}{2}}$

**B**  $\left(\frac{M}{R}\right)^{\frac{1}{2}}$

**C**  $\frac{M}{R}$

**D**  $\left(\frac{M}{R}\right)^2$

**Turn over for the next question**

**Turn over ►**

**1 2**

A satellite is in a circular orbit at a height  $h$  above the surface of a planet of mass  $M$  and radius  $R$ .

What is the linear speed of the satellite?

**[1 mark]**

A  $\frac{\sqrt{GM}}{(R+h)}$

B  $\sqrt{\frac{GM}{(R+h)}}$

C  $\frac{GM}{\sqrt{R+h}}$

D  $\frac{GM}{(R+h)}$

**1 3**

Which statement is **not** true for a satellite in a geostationary orbit?

**[1 mark]**

A The satellite orbits in the plane of the Earth's equator.

B The satellite has the same angular velocity as a point on the Earth's surface.

C The satellite takes 24 hours to orbit the Earth.

D Signals from the satellite can be sent to any point on the Earth's surface during one orbit.



1 4

Six metal spheres, each carrying a charge of magnitude  $Q$ , are equally spaced around a circle of diameter  $d$ .

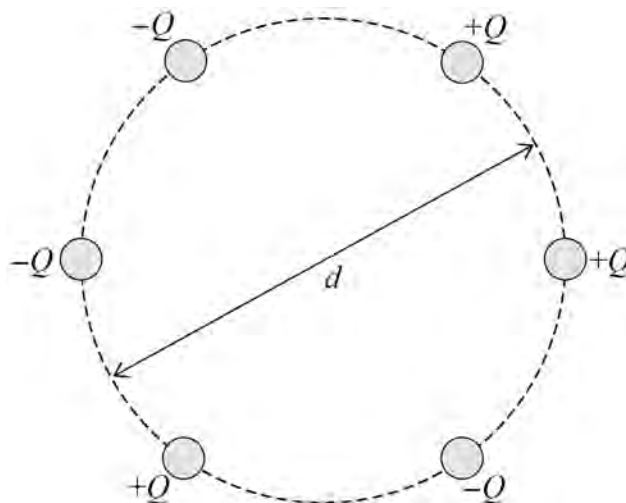

What is the magnitude of the field strength at the centre of the circle?

[1 mark]

A 0

B  $\frac{Q}{\pi\epsilon_0 d^2}$

C  $\frac{2Q}{\pi\epsilon_0 d^2}$

D  $\frac{4Q}{\pi\epsilon_0 d^2}$

1 5

Two point charges are separated by a distance of 200 mm.

The force of attraction between them is  $180 \mu\text{N}$ .

The distance between the point charges is increased by 400 mm.

What is the new force of attraction?

[1 mark]

A  $20 \mu\text{N}$

B  $45 \mu\text{N}$

C  $60 \mu\text{N}$

D  $90 \mu\text{N}$

Turn over ►



**1 6**

The diagram shows the path of an electron in a uniform electric field.  
The electron moves in a vertical plane.

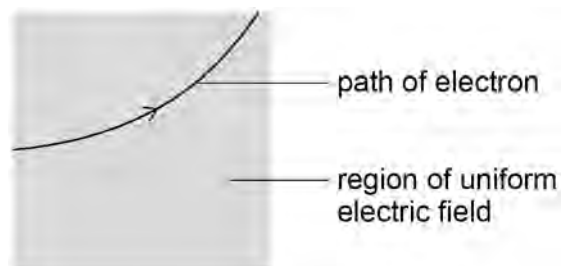

The direction of the electric field is

[1 mark]

- A** vertically down the plane.
- B** vertically up the plane.
- C** horizontally into the plane.
- D** horizontally out of the plane.



1 7

The graph shows the variation of electric field strength  $E$  surrounding a charged sphere of radius  $R$ . The distance from the centre of the sphere is  $r$ .

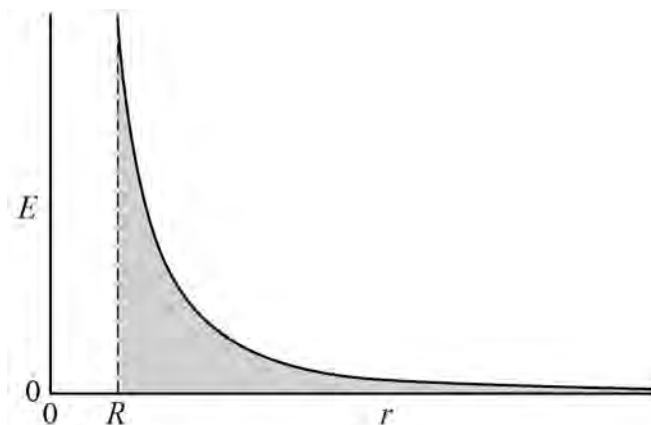

The total area under the curve from  $R$  to infinity is

[1 mark]

- A** the capacitance of the sphere.
- B** the charge held on the sphere.
- C** the electric potential of the sphere.
- D** the energy needed to remove an electron from the sphere.

Turn over for the next question

Turn over ►



**1 8**

A polar molecule is in an external electric field.

Do not write  
outside the  
box

Which diagram shows the orientation of the polar molecule?

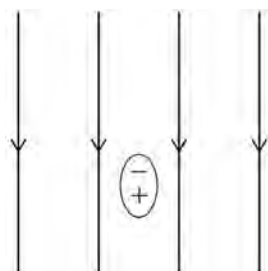
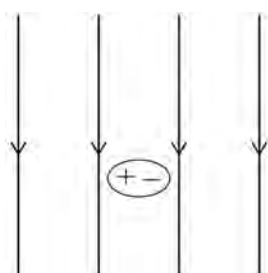
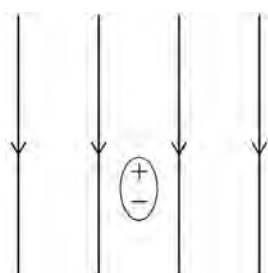
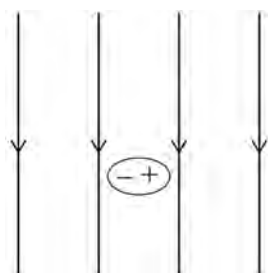
**[1 mark]****A****B****C****D**



**1 9**

An alpha particle is moving towards a stationary gold nucleus. The alpha particle has a kinetic energy of  $9.0 \times 10^{-13}$  J when it is a large distance from the gold nucleus. The gold nucleus contains 79 protons.

What is the closest possible distance of approach of the alpha particle to the gold nucleus? **[1 mark]**

**A**  $2.5 \times 10^{-16}$  m

**B**  $2.0 \times 10^{-14}$  m

**C**  $4.0 \times 10^{-14}$  m

**D**  $2.0 \times 10^{-7}$  m

**2 0**

A wire is at right angles to a uniform magnetic field and carries an electric current. The wire is 150 mm in length.

When the current in the wire is increased by 4.0 A, the force acting on the wire increases by  $3.6 \times 10^{-3}$  N.

What is the magnetic flux density of the field?

**[1 mark]**

**A**  $6.0 \times 10^{-6}$  T

**B**  $6.0 \times 10^{-3}$  T

**C**  $1.7 \times 10^2$  T

**D**  $1.7 \times 10^5$  T

**Turn over for the next question**

**Turn over ►**

2	1
---	---

A beam consists of ionised atoms of two isotopes of an element. When the beam enters a uniform magnetic field, the ions move in circular paths. The ions have the same charge and travel at the same speed when they enter the magnetic field.

Which statement is true?

[1 mark]

- A** The force acting on an ion is different for each isotope.
- B** The radius of the path followed by an ion is different for each isotope.
- C** The kinetic energy of an ion increases for both isotopes.
- D** The acceleration of an ion is the same for both isotopes.



2 2

The magnetic flux  $\phi$  in a coil varies with time  $t$  as shown.

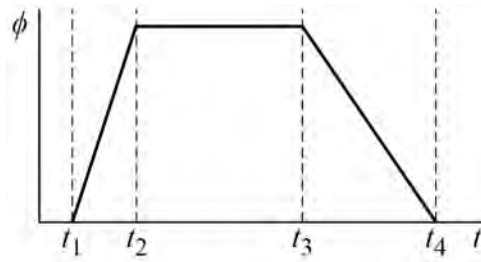

Which graph shows how the emf  $\epsilon$  induced in the coil varies with  $t$ ?

[1 mark]

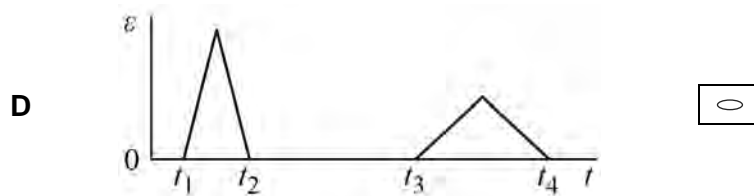
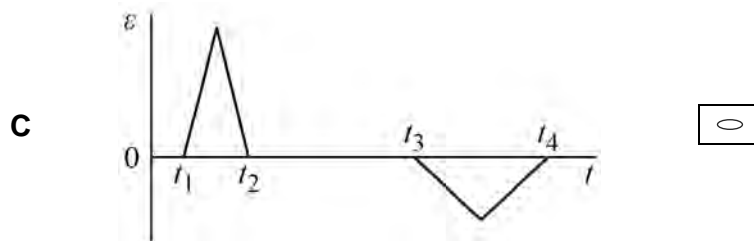
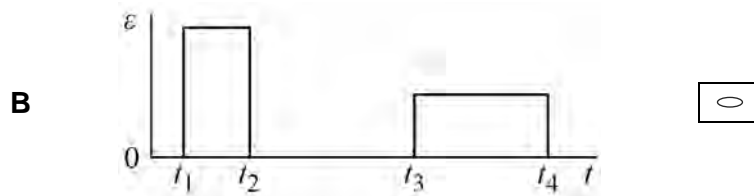
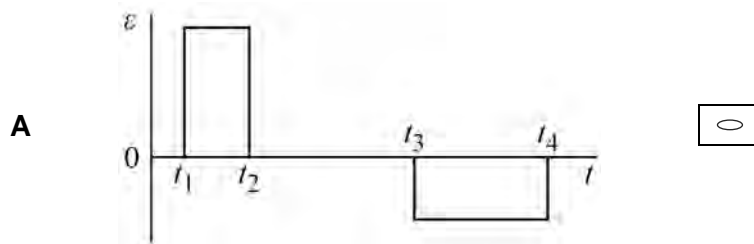

Turn over ►



**2 3**

The distance between the wing tips of a metal aircraft is 30 m.  
The aircraft flies horizontally at a steady speed of  $100 \text{ m s}^{-1}$ .  
The aircraft passes through a vertical magnetic field of flux density  $2.0 \times 10^{-7} \text{ T}$ .

What is the emf induced between its wing tips?

**[1 mark]**

**A**  $0.2 \mu\text{V}$

**B**  $20 \mu\text{V}$

**C**  $300 \mu\text{V}$

**D**  $600 \mu\text{V}$

**2 4**

A circular coil with a radius of 0.10 m has 200 turns.  
The coil rotates at 50 revolutions per second about an axis which is perpendicular to a uniform magnetic field and in the plane of the coil.  
The magnetic flux density of the field is 0.20 T.

What is the maximum emf induced in the coil?

**[1 mark]**

**A** 63 V

**B** 126 V

**C** 195 V

**D** 395 V

**2 5**

After radioactive waste is removed from a cooling pond, it is often stored in underground caves.

This is to protect workers from the effects of

**A** alpha particles from nuclides with a large decay constant.

**B** alpha particles from nuclides with a small decay constant.

**C** gamma radiation from nuclides with a large decay constant.

**D** gamma radiation from nuclides with a small decay constant.



**2 6**

Alpha particle scattering can be demonstrated using a thin gold foil.

Which statement about this demonstration is **not** true?

**[1 mark]**

- A** The foil is thin enough to assume that alpha particles are deflected only once.
- B** Nuclei are more massive than alpha particles which allows the alpha particles to be deflected by more than  $90^\circ$ .
- C** The number of alpha particles deflected backwards is greater than the number that pass straight through the foil.
- D** Deflections of alpha particles by electrons in the foil are much smaller than deflections due to nuclei.

**2 7**

A transformer for use in a 230 V ac supply is 90% efficient.

The transformer provides a current of 3.00 A at 12.0 V.

What is the current in the primary coil?

**[1 mark]**

- A** 0.141 A
- B** 0.156 A
- C** 0.174 A
- D** 5.75 A

**2 8**

The random nature of radioactive decay means that it is never possible to predict

**[1 mark]**

- A** when a particular nucleus will decay.
- B** whether a  $\beta^-$  particle or a  $\beta^+$  particle is emitted.
- C** the approximate time taken for the activity to decrease to a specified value.
- D** the approximate thickness of an absorber needed to reduce the count rate to a specified value.

**Turn over ►**

**2 9**

Radiation is used to measure the thickness of an aluminium sheet accurately. The thickness of the sheet is about 0.5 mm.

Which type of radiation is most appropriate for the measurement?

**[1 mark]**

**A**  $\alpha$

**B**  $\beta^-$

**C**  $\beta^+$

**D**  $\gamma$

**3 0**

Tritium is a radioactive nuclide used in 'Exit' signs. When a sign was manufactured the activity of the tritium in it was 37 MBq. After 10 years the tritium in the sign has an activity of 21 MBq.

What will the activity be 15 years after it was manufactured?

**[1 mark]**

**A** 12 MBq

**B** 13 MBq

**C** 16 MBq

**D** 17 MBq

**3 1**

The mass of fuel in a nuclear reactor decreases at a rate of  $4.0 \times 10^{-6}$  kg per hour.

What is the rate at which energy is transferred due to nuclear fission?

**[1 mark]**

**A**  $4.0 \times 10^7$  W

**B**  $1.0 \times 10^8$  W

**C**  $6.0 \times 10^8$  W

**D**  $3.6 \times 10^{10}$  W



3 2

The graph shows the variation of activity with time for a sample of a nuclide **X**.

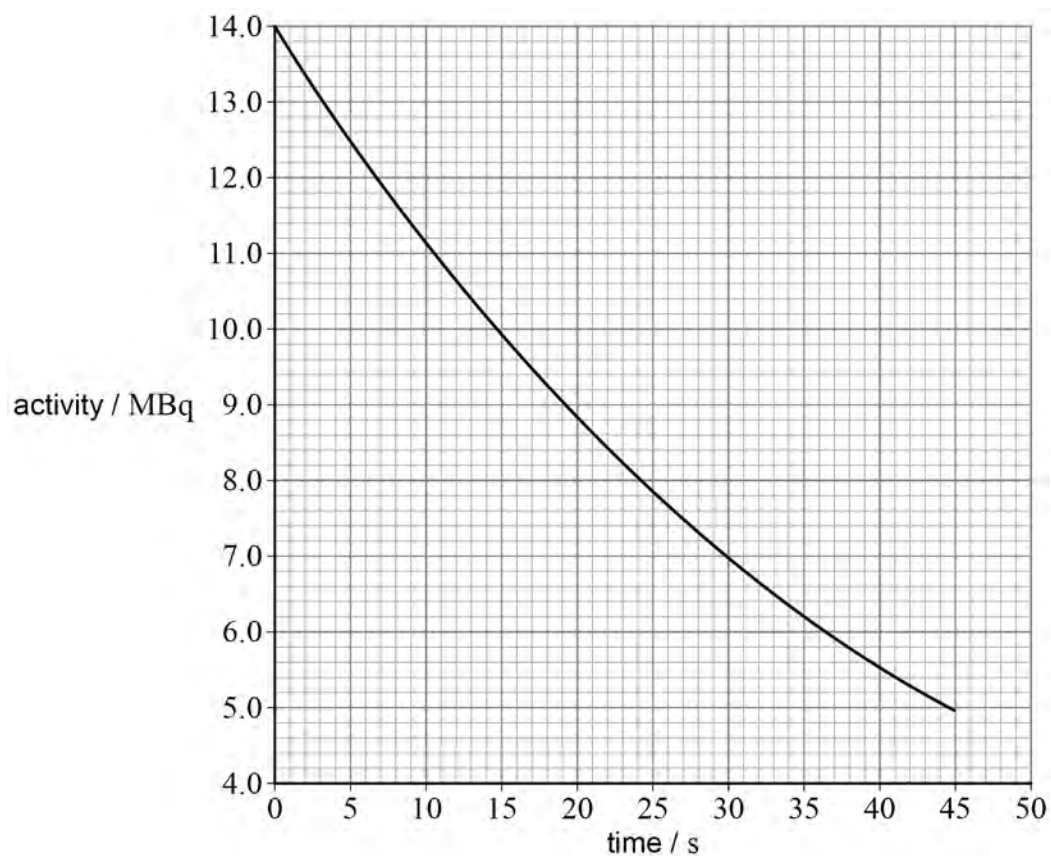

What was the initial number of nuclei of **X** in the sample?

[1 mark]

- A**  $4.67 \times 10^5$
- B**  $3.0 \times 10^8$
- C**  $4.2 \times 10^8$
- D**  $6.1 \times 10^8$

25

**END OF QUESTIONS**



**There are no questions printed on this page**

*Do not write  
outside the  
box*

**DO NOT WRITE ON THIS PAGE  
ANSWER IN THE SPACES PROVIDED**











**There are no questions printed on this page**

*Do not write  
outside the  
box*

**DO NOT WRITE ON THIS PAGE  
ANSWER IN THE SPACES PROVIDED**

**Copyright information**

For confidentiality purposes, all acknowledgements of third-party copyright material are published in a separate booklet. This booklet is published after each live examination series and is available for free download from [www.aqa.org.uk](http://www.aqa.org.uk).

Permission to reproduce all copyright material has been applied for. In some cases, efforts to contact copyright-holders may have been unsuccessful and AQA will be happy to rectify any omissions of acknowledgements. If you have any queries please contact the Copyright Team.

Copyright © 2023 AQA and its licensors. All rights reserved.

